

ledix

LED lighting fitting MUNA with a radio receiver



A lighting fitting with a built-in radio receiver cooperating with transmitters of EXTA FREE system



Mounting
indoor only



Mounting
in a Ø60 junction box.

MUNA with a built-in radio receiver is a high quality LED fitting with decorative and application features. It is used for lighting corridors, passageways, for decorative lighting of furniture and lighting arrangement in the interior design.

The features of the fitting:

- luminous flux emitted in two planes; lower and front
- wireless control – cooperation with chosen wireless transmitters of EXTA FREE system,
- realisation one out of three operation modes: switch on / switch off (ON/OFF), brightening/ dimming, time mode with dimming,
- excellent lighting parameters obtained by applying the highest quality LED diodes by CREE,
- high quality and durability estimated to light continuously for five year.

CAUTION:

- Power supplies of ZNP and ZNN series and of ZNM series in 14 V DC version by Cet Lighting are used to supply the fittings.

TRANSMITTERS COOPERATING WITH MUNA LIGHTING FITTING



Operation range from 40 to 50 m in the open area



Application:



stairs



corridors, passageways

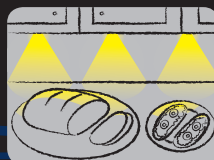

furniture, decorative lighting

zameL cet

LED lighting fitting MUNA with a radio receiver



14 V DC

ledix

zameL cet

Cet Lighting Sp. z o.o.

PL 43-200 Pszczyna, ul. Zielona 27, Poland

tel: +48 32 449 15 00, fax: +48 32 449 15 02

e-mail: ledix@ledix.pl, www.ledix.pl

14 V DC; IP20
weight: 149 g

Cet Lighting Sp. z o.o.
declares that the device
is consistent with
the essential requirements
and other relevant
provisions of the RTTE Directive.

Declaration of Conformity is on www.ledix.pl



The symbol means selective
collecting of electrical and
electronic equipment.
It is forbidden to put the used
equipment together with other
waste.

TRANSMITTERS' DELETION

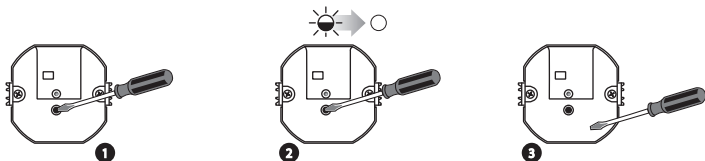

1 Press PROG push-button in the fitting for a longer time

2 After 5 seconds STATUS LED red diode switches on and switches off

3 Release PROG push-button in the fitting - THE MEMORY IS DELETED

INSTALLATION EXAMPLE

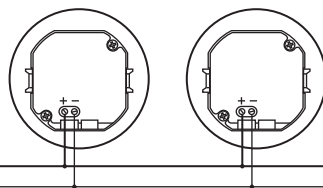

ZNP, ZNN or ZNM power supply in 14 V DC version

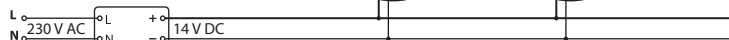

MOUNTING

The device is designed for single-phase installation and must be installed in accordance with standards valid in a particular country. Installation, connection and control should be carried out by a qualified electrician staff, who act in accordance with the service manual and the device functions.

Fitting is designed for mounting in Ø60 junction box.

1. Disconnect power supply by the phase fuse, the circuit-breaker or the switch-disconnector combined to the proper circuit.
2. Check if there is no voltage on connection cables by means of a special measure equipment.
3. Connect the 14 V DC power supply to 230 V AC.
4. Remove the fitting - with the help of fingers hold the control module and move the fitting upward (as shown in the Figure) and gently pull away from the mounting element.
5. Disconnect the connecting cables between the fitting and the control module.
6. Connect the installation cables into the appropriate terminals of the control module in accordance with the selected connection diagram, maintaining the correct polarity.
7. Mount the control module in a Ø60 junction box and tighten the screws.
8. Add a transmitter to a lighting fitting. A detailed description referring to these activities is in the operation mode programming section.
9. Connect the fitting cables with the module mounted in Ø60 junction box.
10. Mount the front of the fitting on the mounting element.
11. Switch on the power supply from the mains.
12. Check if the fitting works properly.

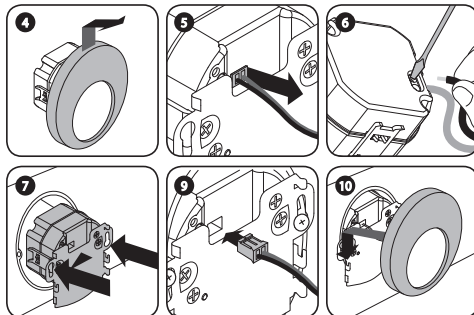

TECHNICAL DATA

Supply voltage	14 V DC	
Power consumption	0,74 W - cold white	
	0,60 W - warm white	
	0,46 W - red	
	0,46 W - green	
	0,46 W - blue	
	cold white	warm white
Colour rendering index R_a	71	80
Colour temperature T_C [K]	5900	3100
Luminous flux Φ [lm]	18	12
Luminous efficiency [lm/W]	32	29

IP20



Protection degree suitable for indoor use only



The fitting cooperates with photovoltaic cells



The lighting fitting cooperates with chosen transmitters of EXTA FREE system

4xLED

Light source - four LED diodes

const

Built-in LED diode current stabilization system

COOPERATION WITH EXTA FREE TRANSMITTERS

MUNA lighting fitting with a built-in radio receiver cooperates with chosen wireless transmitters of EXTA FREE system (www.extafree.pl). The operation range depends on the transmitter's type.

Transmitter's symbol	Mounting	Range* [m]	Operation modes		
RNK-02	surface	50	ON/OFF mode		
RNK-04		50			
RNP-01	flush	40		Brightening/dimming	
RNP-02		40			
RNM-10	TH-35 rail	50			Time mode
RXM-01		50			
P-257/2	portable remote control	40	ON/OFF mode		
P-257/4		40			
P-256/8		50			
RTI-01	surface	40		ON/OFF mode	
RCR-01		40			

* CAUTION: The given range concerns open area - an ideal condition without any natural or artificial obstacles. If there are some obstacles between a transmitter and a receiver, it is advisable to decrease the range according to: bricks: from 10 to 40%, wood and plaster: from 5 to 20%, reinforced concrete: from 40 to 80%, metal: from 90 to 100%, glass: from 10 to 20%. Over- and underground medium and high electrical power lines, radio and television transmitters, GSM transmitters set close to a device system have also a negative influence on the range.

OPERATION MODES

The operating mode is defined during transmitters' programming phase. The programming procedure is simply adding a specific transmitter to a selected LED fitting with a built-in radio receiver. Different functions can be assigned to each transmitter depending on how it is added to the lighting fitting. 32 transmitters of EXTA FREE system can be added to a single fitting. Full transmitters' memory is indicated by a pulsating STATUS LED red diode in the programming stage of subsequent transmitters.

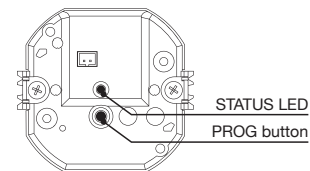

ON/OFF MODE

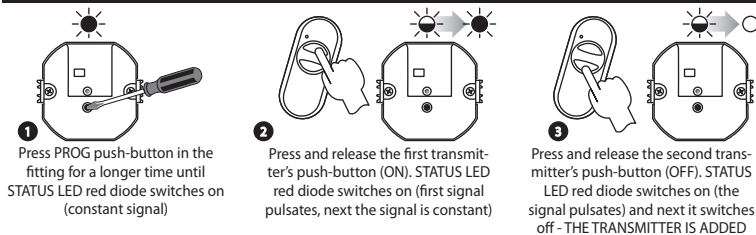

ON / OFF mode is realised only on two different transmitter's push-buttons.

In this mode, the fitting is switched on by pressing the programmed push-button as (ON) and switched off by pressing by pressing the programmed push-button as (OFF).

BRIGHTENING/DIMMING MODE

Brightening/dimming mode is realised only on two different transmitter's push-buttons.

In order to realise the brightening / dimming the transmitter should be programmed in ON / OFF mode (see above).

Pressing the (ON) push-button for a longer time (> 3s) realises the brightening function to the maximum level.

Pressing the (OFF) push-button for a longer time (> 3s) realises the dimming function to the minimum level.

TIME MODE

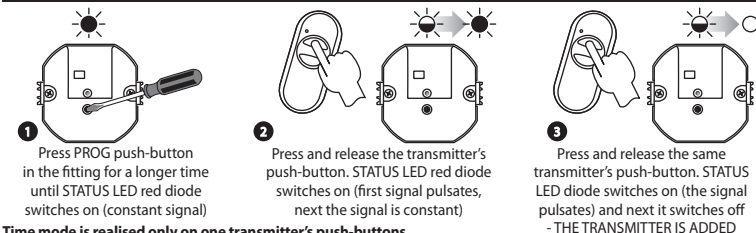

Time mode is realised only on one transmitter's push-buttons.

The fitting switches on by pressing the chosen transmitter's push-button and switches off automatically after the programmed time is over (from 1 s to 18 h) or by pressing the transmitter's push-button again. Switching off is carried out by smooth dimming for time $t \sim 10$ s. Each time the chosen transmitter's push-button is pressed during dimming causes the time is counted again (retrigable time). In time mode, brightening / dimming is realised by longer pressing the chosen push-button.

TIME PROGRAMMING

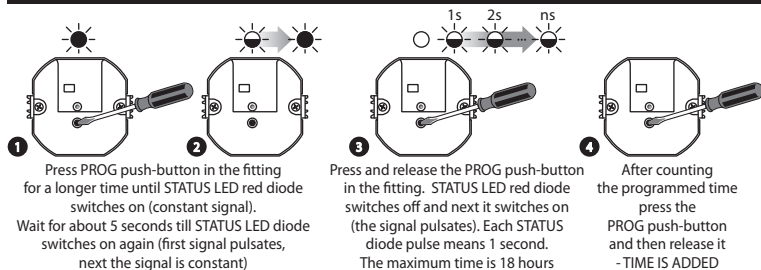

COOPERATION WITH RCR-01 RADIO MOTION SENSOR

The fitting cooperates with RCR-01 radio motion sensor (www.extafree.pl). It includes two modes:

MODE 1 - only the motion sensor. Change the RCR-01 switch into „C” position.

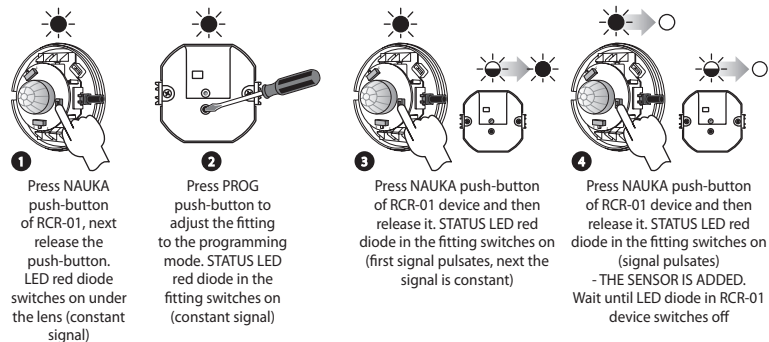

Additionally, in this mode, time programming should be done in the fitting. The time value should be adjusted to the minimum of 15 seconds. The cooperation between the motion sensor and the fitting is that while in the detection zone the sensor detects movement, it sends a signal every 10 seconds to the fitting. After the signal has been sent, time counting starts from the beginning.

CAUTION: Each time a push-button is pressed in the motion sensor there are 10 seconds to start the next step of the programming procedure. After this time, the sensor begins normal operation.

MODE 2 - motion sensor with a twilight switch. Change the RCR-01 switch into „F” position.

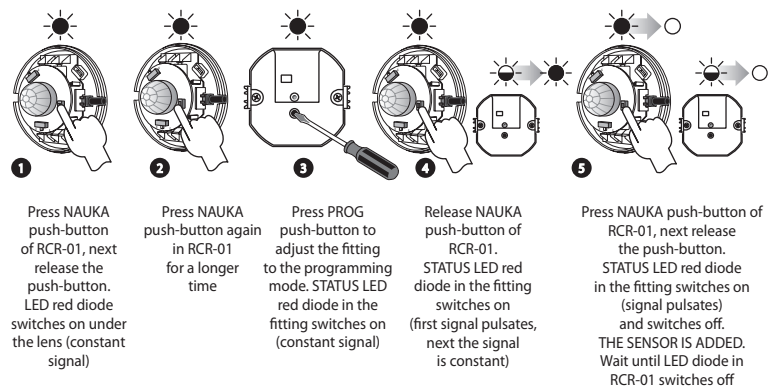

The cooperation between the motion sensor and the fitting is that while in the detection zone the sensor detects movement, it sends a switch on signal to the fitting. The switch off signal is sent by the sensor after 20 seconds from the time of no motion in the detection zone.

CAUTION: Each time a push-button is pressed in the motion sensor there are 10 seconds to start the next step of the programming procedure. After this time, the sensor begins normal operation.