

ledix

LED lighting fitting NAVI with battery backup



A fitting with a built-in NiMH battery



Mounting
indoor only



Mounting
in a Ø60 junction box.

NAVI with a built-in battery backup is a high quality LED fitting with decorative and application features. It is used for lighting corridors, passageways, for decorative lighting of furniture and lighting arrangement in the interior design.

The features of the fitting:

- a built-in NiMH battery
- maintaining the lighting function for time $t \sim 1,5$ hour since power supply failure
- a possibility of switching on / off by means of a typical switch
- automatic battery charging time for maximum 10 hours
- a full control of the battery charging process by means of an electronic system
- excellent lighting parameters obtained by applying the highest quality LED diodes by CREE
- high quality and durability estimated to light continuously for five years ($\sim 40\,000$ h).

CAUTION:

- Power supplies of ZNP and ZNN series and of ZNM series in 14 V DC version by Cet Lighting are used to supply the fittings.
- Power supply should be adjusted to the number of powered fittings.



Application:



stairs



corridors, passageways

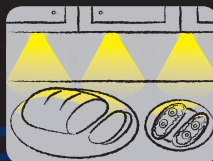

furniture, decorative lighting

zameL cet

LED lighting fitting NAVI with battery backup



14 V DC

ledix

zameL cet

Cet Lighting Sp. z o.o.
PL 43-200 Pszczyna, ul. Zielona 27, Poland
tel: +48 32 449 15 00, fax: +48 32 449 15 02
e-mail: ledix@ledix.pl, www.ledix.pl

14 V DC; IP20
weight: 164 g



Declaration of Conformity
is on www.ledix.pl



The symbol means selective collecting of electrical and electronic equipment.
It is forbidden to put the used equipment together with other waste.

TECHNICAL DATA

Supply voltage	14 V DC	
Power consumption	0,84 W – cold white	
	0,70 W – warm white	
	0,57 W – red	
	0,57 W – green	
	0,57 W – blue	
Battery backup time	maximum 1,5 h	
Battery charging time	maximum 10 h	
Colour rendering index R_a	cold white	warm white
	71	80
Colour temperature T_c [K]	5900	3100
Luminous flux Φ [lm]	37	24
Luminous efficiency [lm/W]	66	57

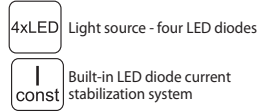
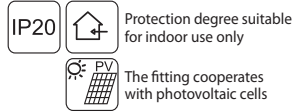

DESCRIPTION

The fitting has a built-in battery backup (BACKUP) realised on the NiMH battery. In addition to the maintaining function, the fitting can be operated in a switch on / switch off mode from the typical electrical installation switch. The NiMH battery capacity allows the fitting to operate up to 1,5 hour since the power supply failure. When the supply voltage is on the battery is charged for about 10 hours. The battery charging process is fully controlled by means of an electronic system - this is designed to extend the battery life. When operating on a battery the luminous flux is automatically reduced by 50%.

MOUNTING

The device is designed for single-phase installation and must be installed in accordance with standards valid in a particular country. Installation, connection and control should be carried out by a qualified electrician staff, who act in accordance with the service manual and the device functions.

Fitting is designed for mounting in $\varnothing 60$ junction box.

1. Disconnect power supply by the phase fuse, the circuit-breaker or the switch- disconnector combined to the proper circuit.
2. Check if there is no voltage on connection cables by means of a special measure equipment.
3. Connect the 14 V DC power supply to 230 V AC.
4. Remove the fitting – with the help of fingers hold the control module and gently pull away the fitting from the mounting element – if necessary, use a slot drive screwdriver by inserting it into the notch in the casing.
5. Disconnect the connecting cables between the fitting and the control module.

6. Connect the installation cables into the appropriate terminals of the control module in accordance with the selected connection diagram, maintaining the correct polarity.
7. Mount the control module in a $\varnothing 60$ junction box and tighten the screws.
8. Connect the fitting cables with the module mounted in $\varnothing 60$ junction box.
9. Mount the front of the fitting on the mounting element.
10. Switch on the power supply from the mains.
11. Check if the fitting works properly.

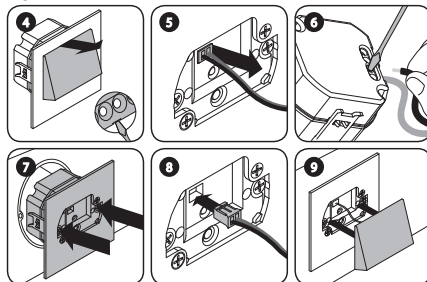

INSTALLATION EXAMPLE

Figure 1. Battery backup

The fitting remains switched on - during normal operation it is supplied by the 14 V DC power supply. After a power supply failure the fitting is supplied from the built-in battery for 1,5 hour. When the supply voltage is on the battery is charged again.

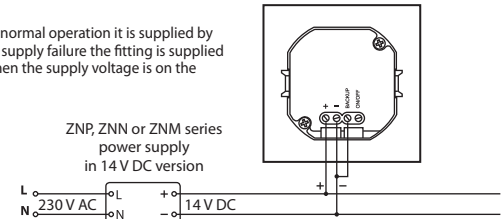

Figure 2. Battery backup with a possibility of manual switch on

When there is a supply voltage the fitting is switched on / switched off by means of the ON / OFF switch. After there is a power supply failure the lighting fitting remains switched on or off depending on the status of the BACKUP switch. If the BACKUP function is activated then the control by means of a switch is not possible. During battery operation there is a possibility to switch off the lighting fitting by changing the BACKUP switch position.

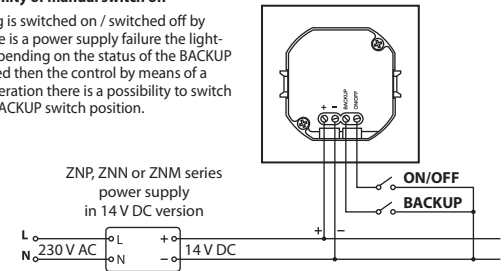
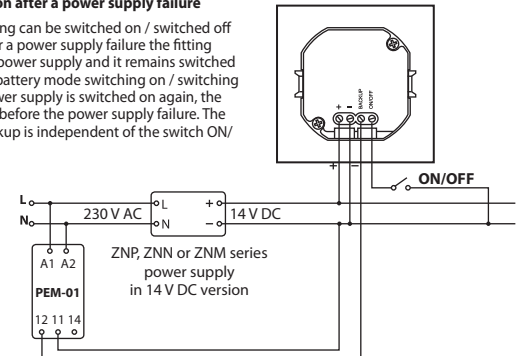

Figure 3. Automatic backup switch on after a power supply failure

When the supply voltage is on the fitting can be switched on / switched off by means of the ON / OFF switch. After a power supply failure the fitting automatically switches to the battery power supply and it remains switched on for a maximum of 1,5 hour. In the battery mode switching on / switching off the fitting is not possible. After power supply is switched on again, the fitting returns to the same position as before the power supply failure. The lighting function with the battery backup is independent of the switch ON / OFF position.



CAUTIONS

- 14 V DC power supplies from the Cet Lighting product offer (ZNP, ZNN, ZNM series) should be used to supply the fittings.
- The fittings can be combined in a parallel way with proper voltage polarity.
- The battery life depends on the number of charge / discharge cycles - is it related to the number supply voltage failures.
- The functionality of the fitting depends on the connection executed - examples of installation for typical functions were shown in Figures 1 to 3.
- The manufacturer is not liable for damage caused by improper installation and use of the product.