

# ledix

## LED lighting fitting SONA



Recessed installation  
in a hole of  $\varnothing = 60$  mm



The fitting's protection level  
is suitable to be used  
outdoor

SONA is a high quality LED fitting with decorative and application features. It is used for lighting corridors, passageways, for decorative lighting of furniture and lighting arrangement in the interior design.

The features of the fitting:

- protection degree IP44 allows for outdoor mounting
- excellent lighting parameters obtained by applying the highest quality LED diodes by CRE
- repeatability of the light colour
- high lighting output with minimum power consumption
- high quality and durability estimated to light continuously for five years (~40 000 h).

#### CAUTION:

- Power supplies of ZNP and ZNN series and of ZNM series in 14 V DC version by Cet Lighting are dedicated to supply the fittings.
- Power supply should be adjusted to the number of powered fittings.
- The fitting with RGB diodes requires an additional, external RGB controller - it is recommended to use Lighting Cet controllers with the following symbols SLR-11, SLR-12 and SLR-13.



#### Application:



stairs



corridors,  
passageways

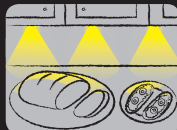

furniture,  
decorative lighting

zaMeL cet

14 V DC

## LED lighting fitting SONA

IP44

zaMeL cet

Cet Lighting Sp. z o.o.

PL 43-200 Pszczyna, ul. Zielona 27, Poland  
tel: +48 32 449 15 00, fax: +48 32 449 15 02  
e-mail: ledix@ledix.pl, www.ledix.pl

14 V DC; IP44  
weight: 58 g



Declaration of Conformity is on [www.ledix.pl](http://www.ledix.pl)



The symbol means selective collecting of electrical and electronic equipment. It is forbidden to put the used equipment together with other waste.

13-211 ENG Ver. 01

## TECHNICAL DATA

Supply voltage	14 V DC	
Power consumption	0,56 W – cold white	
	0,42 W – warm white	
	0,28 W – red	
	0,28 W – green	
	0,28 W – blue	
	0,84 W – fitting with RGB LED diodes	
	cold white	warm white
Colour rendering index R <sub>a</sub>	71	80
Colour temperature T <sub>c</sub> [K]	5900	3100
Luminous flux Ø [lm]	23	15
Luminous efficiency [lm/W]	41	36

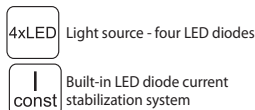
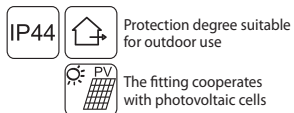

## MOUNTING

SONA fitting is designed to be mounted in an opening or in Ø60 junction box.

**The device is designed for single-phase installation and must be installed in accordance with standards valid in a particular country. Installation, connection and control should be carried out by a qualified electrician staff, who act in accordance with the service manual and the device functions.**

1. Disconnect power supply by the phase fuse, the circuit-breaker or the switch-disconnector combined to the proper circuit.
2. Check if there is no voltage on connection cables by means of a special measure equipment.
3. Connect the 14 V DC power supply to 230 V AC.
4. Connect the output cables of the power supply with the fitting wires with proper polarity (red wire of the fitting means „+“ power).
5. In case of a fitting with RGB LED diodes the power supply output cables should be connected to corresponding terminals of the RGB controller. The RGB fitting cables with proper sequence should be connected with the RGB controller.
6. Mount the fitting in the opening or in Ø60 junction box.
7. Switch on the power supply from the mains.
8. Check if the fitting works properly.

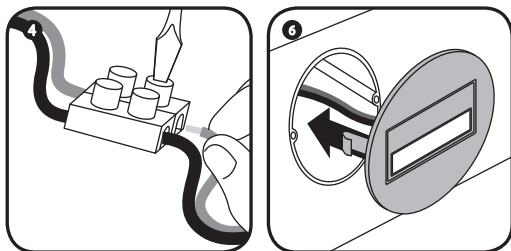

## INSTALLATION EXAMPLES

### SONA fitting – single colour LED diodes

Figure 1. Fittings connected in a parallel way. The power supply is chosen according to the number of fittings.

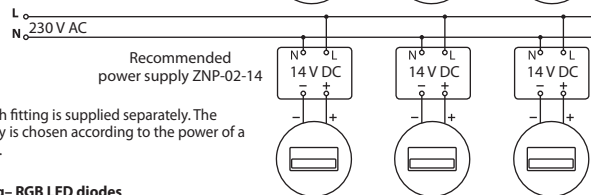
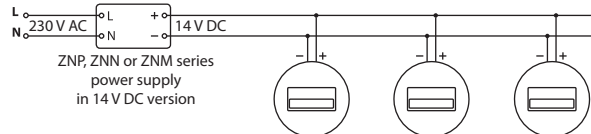

Figure 2. Each fitting is supplied separately. The power supply is chosen according to the power of a single fitting.

### SONA fitting – RGB LED diodes

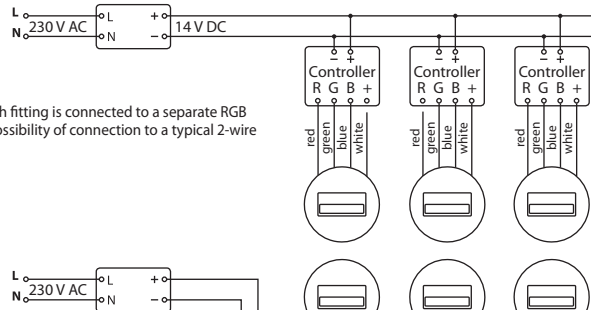

Figure 3. Each fitting is connected to a separate RGB controller. Possibility of connection to a typical 2-wire installation.

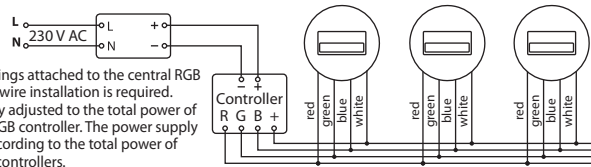

Figure 4. Fittings attached to the central RGB controller. 4-wire installation is required. Power supply adjusted to the total power of fitting and RGB controller. The power supply is chosen according to the total power of fittings and controllers.

## CAUTIONS

- 14 V DC power supplies from the Cet Lighting product offer (ZNP, ZNN, ZNM series) should be used to supply the fittings.
- Power supply must be chosen according to the amount of fittings and the way of their installation.
- The light source in fittings is not replaceable - if damaged, replace the entire fitting.
- In case of fittings with standard light colours, the red wire means „+“ power.
- Fittings with RGB LED diodes require an additional external RGB controller.
- One central RGB controller can be used for a few fittings (4 - wire installation) or a separate controller for each fitting (2 - wire installation).
- In case of RGB controllers, it is recommended to use the controllers from the Cet Lighting product offer with the following symbols SLR-11, SLR-12, SLR-13.
- The manufacturer is not liable for damage caused by improper installation and use of the product.